



LoRa Remote I/O

UC1122 User Guide



Contents

1. Preface.....	3
2. Introduction.....	3
2.1 Features.....	3
2.2 Parameters.....	4
2.3 LED Indicator Description.....	4
3. Installation.....	5
3.1 Environment.....	5
3.2 Power Supply.....	5
3.3 Micro USB Port.....	6
3.4 Terminal Description.....	6
3.5 Analog Input.....	6
3.6 Digital Input.....	7
3.7 Relay Output.....	7
4. Configuration.....	9
4.1 Configuration via PC.....	9
4.1.1 Serial Port Settings.....	10
4.2 Status.....	11
4.3 General.....	12
4.4 LoRaWAN.....	14
4.4.1 Basic.....	14
4.4.2 Channel.....	17
4.4.3 Advanced.....	18
4.5 Command.....	20
4.5.1 Read Command from Device.....	20
4.5.2 Open a Command File.....	20
4.5.3 Save the Command to Device.....	21
4.5.4 Save the Command as File.....	21
4.6 IF-THEN Behaviour Command.....	21
4.6.1 Supported IF Condition.....	21
4.6.2 Supported THEN Actions.....	24
4.7 Upgrade.....	26
5. Application Examples.....	27
5.1 Periodic Status Report.....	27
5.2 Control Appliances.....	27
5.2.1 Control a Bulb by Sending a Message.....	27
5.2.2 Turn on the Heater Regularly.....	28
5.2.3 Send an Alert When Over-temperature Occurs.....	29

1. Preface

Thank you for choosing Ursalink UC1122 LoRa Remote I/O. This user guide will present in detail all the functions and features of the product. Ursalink UC1122 is designed for both industrial and commercial applications. The product should be used under the guidance of this user guide, referring to parameters and technical specifications. The UC1122 is a compact, high-performance device that offers LoRaWAN connectivity for data transmission

We bear no liability for property loss or physically injury arising from abnormal or incorrect usage of this product.

2. Introduction

Ursalink UC1122 is designed as a cost-effective industrial machine monitoring device that monitors and controls up to 1 DC signal, 1 drivable relay output and 2 analog inputs.

With the aid of Ursalink UC1122, the alarm condition brings attention to engineering personnel immediately. The output can be connected with an alarm indication device, such as a light or horn.

The module can give immediate response to the status of both the input and output conditions. A LoRa module is embedded in the Ursalink UC1122 .

This user guide is intended to provide detailed technical specifications and explanations to the basic user as well as the technically-minded groups. It is a live document, and will be updated from time to time. Please ensure that you have the latest version, by checking our website at: <https://www.ursalink.com/en/documents-download/>

2.1 Features

- 1 relay drivable output and 1 digital input connected with 1 DC signal
- 2 analog inputs for data acquisition
- Support for 4–20 mA analog devices
- Analog to digital conversion
- Customizable conditions & programmable actions
- Send uplink alert messages according to user-defined conditions
- Automatic switching of field devices at set times
- Comply with the LoRaWAN Class C protocol
- Support star network and mesh network
- High Rx sensitivity and adjustable Tx power

2.2 Parameters

Parameter Item	Reference Scope
Antenna	50 Ω SMA Antenna Interface
Frequency Band	EU 433, CN 470-510, EU 863-870, IN865, US 902-928, AU 915-928, KR 920-923
Sensitivity	-147 dBm @300bps
Output Power	20dBm
Protocol	LoRaWAN Class C
Analog Input	4-20 mA (0-5 V Optional) Differential inputs, 12 bit
Digital Input	Opto-isolated depending on voltage Can accept any DC signals of any type, including: <ul style="list-style-type: none"> ➤ Dry Contacts ➤ DC Voltage (3 - 20V) High Voltage: +3V ~ +24V Low Voltage: +1V max
Digital Output	1 x SPDT Relay Contact Rating: Maximum Load Current: 250VAC/30VDC@3A
IO Connector type	Screw Terminals
DC Power Supply	5-24 VDC
Operating Temperature	-40° C to +70° C (-40° F to +158° F)
Relative Humidity	0% to 95% (non- condensing)
Dimensions	79 x 60 x 24 mm

2.3 LED Indicator Description

System:

- Solid On: System booting
- On for 500ms, off for 500ms: Working properly
- On for 100ms, off for 100ms: Failed to send data

ACT:

- Off: Failed to join network
- On for 75ms, off for 3000ms: Joined the network successfully
- On for 500ms, off for 500ms: Sending/Receiving data

3. Installation

3.1 Environment

Due to the product properties of Ursalink UC1122, we **STRONGLY** advise that it should not be installed in proximity to a variable speed drive or with any other electrically noisy equipment. **DO NOT** install the Ursalink UC1122 into a metal enclosure unless an antenna is mounted on the outside of the enclosure.

3.2 Power Supply

The Ursalink UC1122 features a 2 pin 3.5mm terminal block where a power supply can be connected. The power supply should have the following specifications:

- Output Voltage: 12V nominal
- Output Current: 0.5A
- Installation:

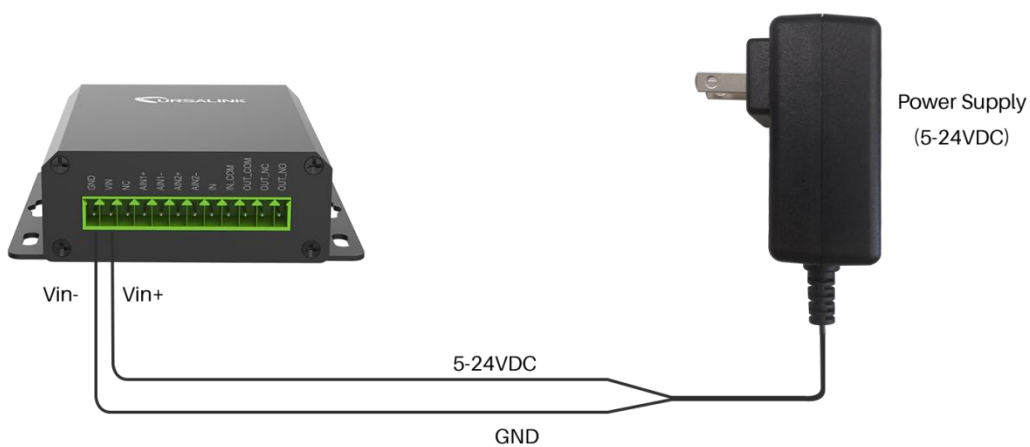

For industrial applications, it is advised that the Ursalink UC1122 should be installed into its own metal housing and be powered from a separate power supply (as opposed to sharing one with other equipment).

Please Note: While the Ursalink UC1122 has fairly rugged internal power supply circuitry, no special provision for lightning protection is well in place. If the Ursalink UC1122 is used in an area where thunderstorm is about to occur, it is advisable to use a commercially available lightning suppressor (the same applies to inputs or outputs that are connected to wires longer than 2 or 3 meters). The guarantee does not cover damage resulting from lightning strikes! The Ursalink UC1122 can operate reliably from voltages in the range of 5 to 24 VDC.

3.3 Micro USB Port

The Ursalink UC1122 provides a micro USB port to connect to a PC via USB cable, which allows the PC to configure the unit.

3.4 Terminal Description

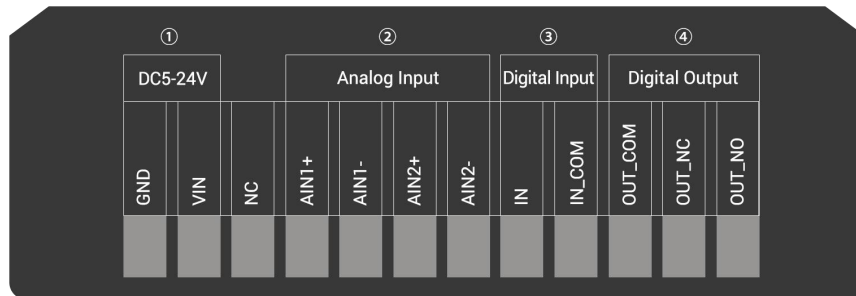

① [DC 5-24V]

Terminal	Description
VIN	Positive terminal of the DC power supply (+)
GND	Negative terminal of the DC power supply (-)

② [Analog Input]

4-20 mA

③ [Digital Input]

Opto-isolated depending on voltage DC Voltage (3-24V)

④ [Digital Output]

Driving relay to connect NC or NO

3.5 Analog Input

- When the value of analog input exceeds or is under the predefined threshold, the Ursalink UC1122 will take action by pre-configured related command.
- Input current: 4-20mA

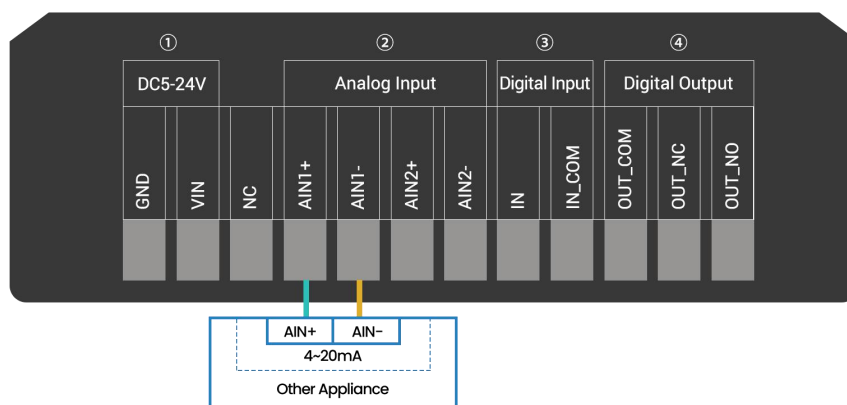

3.6 Digital Input

- When the input is triggered either as high or low, the Ursalink UC1122 will take action if you have pre-configured related commands.
- Terminal "IN" is internally pulled high. Leaving the connection open or connecting it to "0 -1 V" will indicate an "Input-De-activate" state.
- When terminal "IN" is connected to "3-24 V", it will indicate an "Input-Activate" state.
- Trigger voltage: Minimum = 3 VDC, Maximum = 24 VDC.

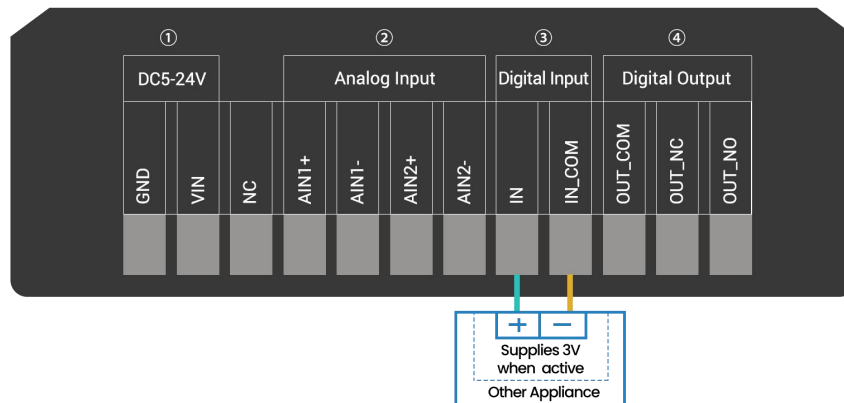

3.7 Relay Output

- The output is used for switch circuits ON & OFF and can be controlled by command message
- The output terminals are internally connected to a 3 Amp SPDT relay
- OUT_NC = Normally Closed
- OUT_COM = Common
- OUT_NO = Normally Open

Maximum Current	3 Amp
Maximum Voltage	250VAC, 30VDC

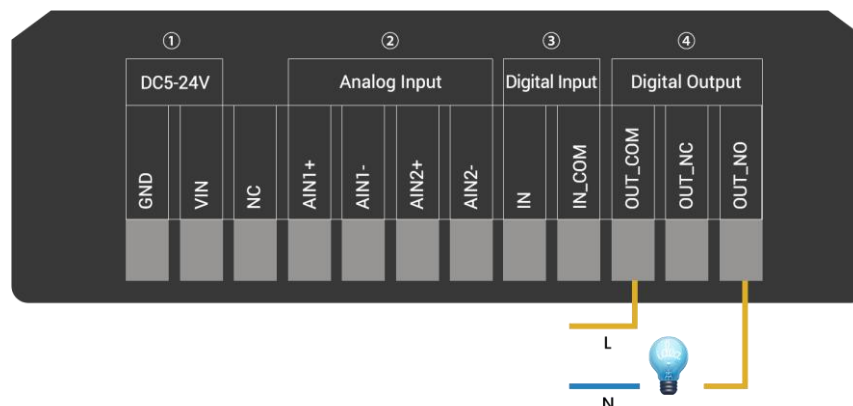

- When the output is off, the COM and N/C terminals will be internally connected to each other. Here is a schematic of the output circuit:

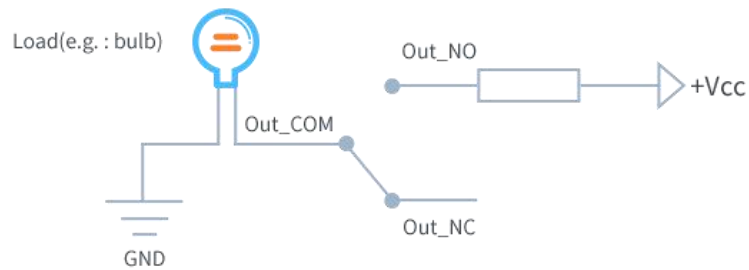

- When the output is on, the COM and N/O terminals will be internally connected to each other. Here is a schematic of the output circuit:

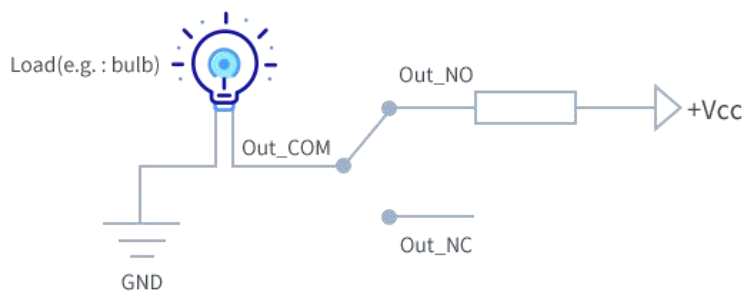

4. Configuration

4.1 Configuration via PC

Follow these steps:

Step 1: Connect UC1122 to PC via the micro USB cable.

Step 2: Power on UC1122.

Step 3: Run the Ursalink ToolBox.

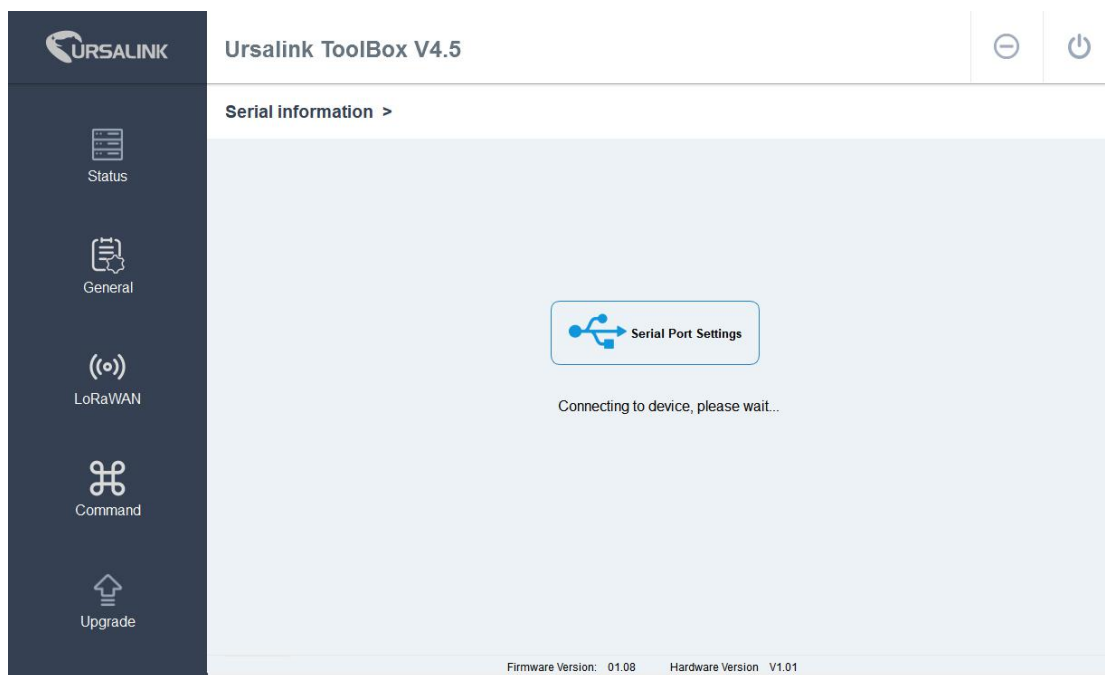

The software will display this interface when getting started. Here you can create a new setup, import an existing setup from your PC, or retrieve the current setup from the Ursalink UC1122.

4.1.1 Serial Port Settings

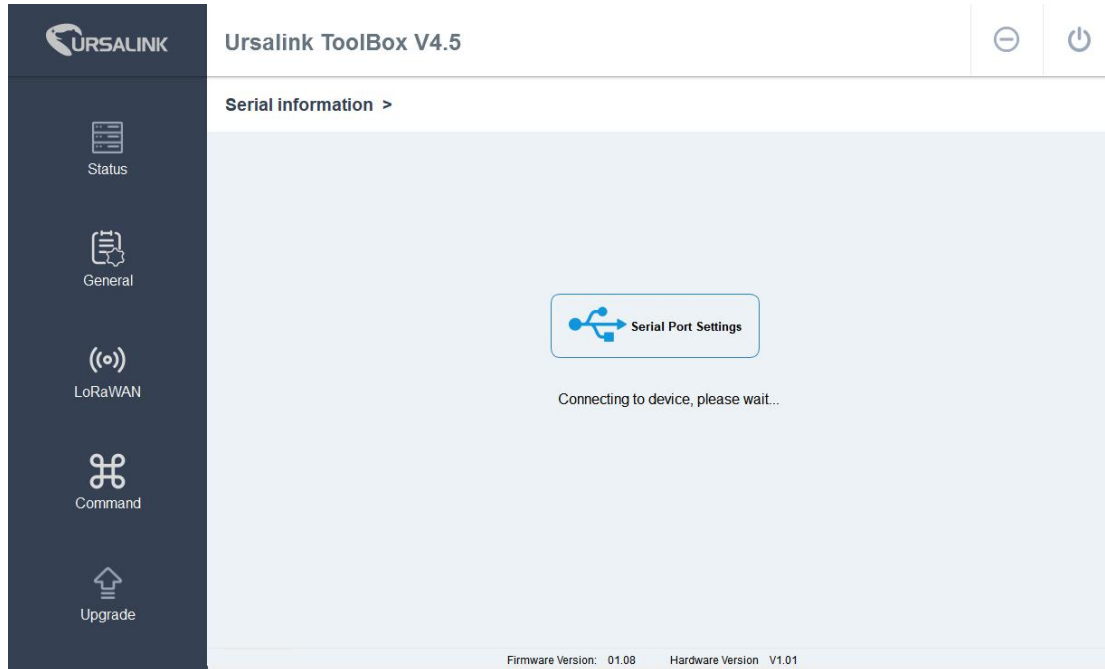

When the Ursalink ToolBox displays: **Connecting to device, please wait...**

You can click **Serial Port Settings** to set the correct serial port parameters.

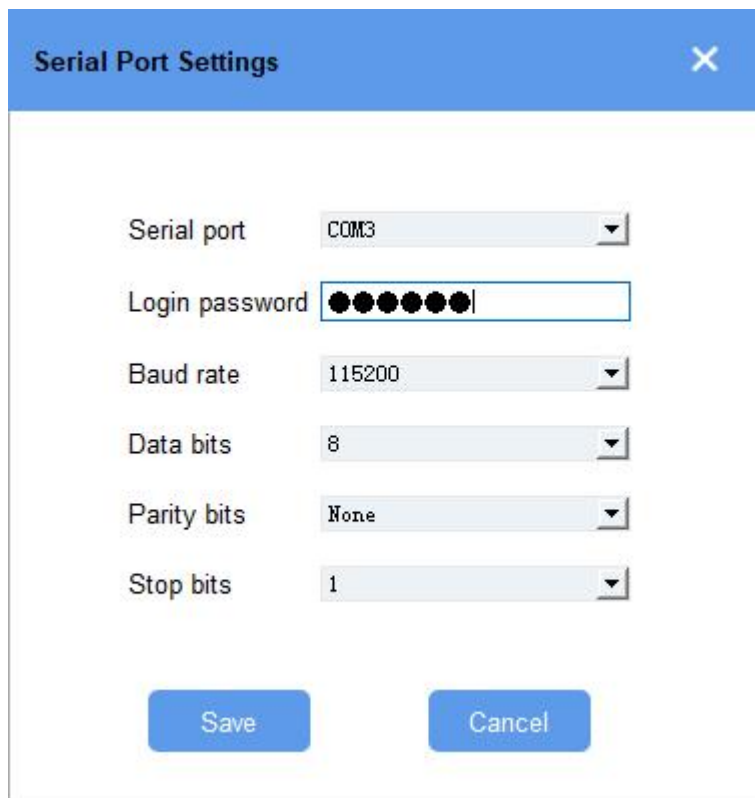

The 'Serial Port Settings' dialog box is shown with the following fields:

Serial port	COM3
Login password	●●●●●●●●
Baud rate	115200
Data bits	8
Parity bits	None
Stop bits	1

At the bottom of the dialog are 'Save' and 'Cancel' buttons.

Serial Port Settings		
Item	Description	Default
Serial Port	Select the serial port for data transmission.	Null
Login Password	Enter the login password.	123456
Baud Rate	Select from "9600", "57600", "115200".	115200
Data Bits	Select from "5", "7", "8".	8
Parity Bits	Select from "Even", "Odd", "None".	None
Stop Bits	Select from "1", "2".	1

If both the serial port parameters and the login password are correct, it will display: Serial port is connected.



4.2 Status

Click "Status" to see the basic status information of this device:

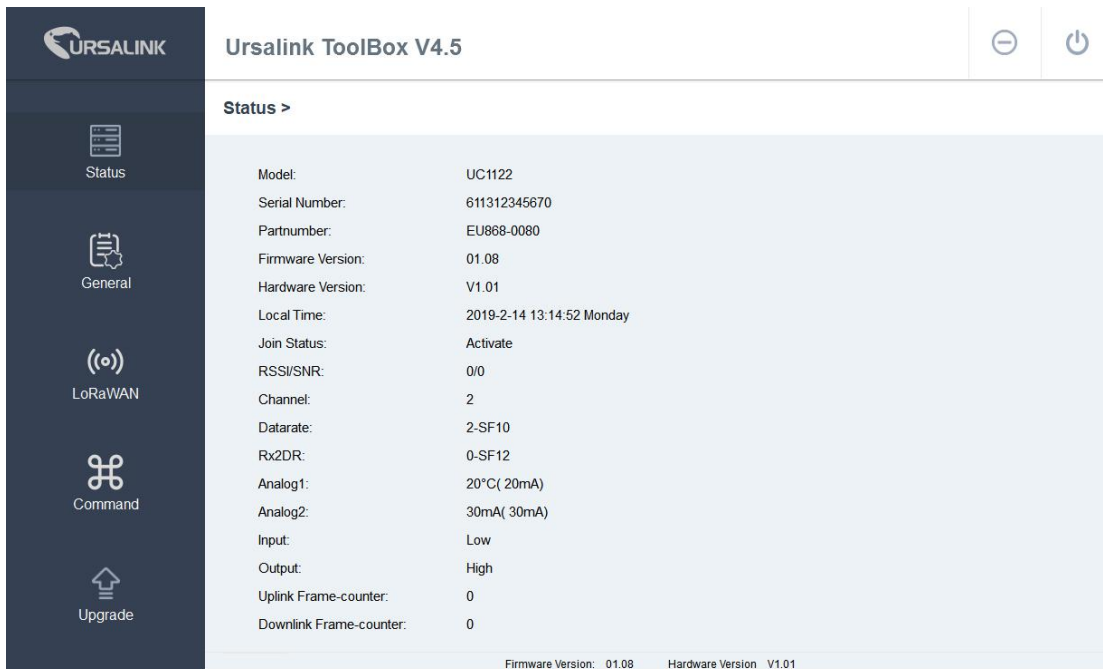

URSALINK URSALINK

Ursalink ToolBox V4.5

Status >

Model: UC1122

Serial Number: 611312345670

Partnumber: EU868-0080

Firmware Version: 01.08

Hardware Version: V1.01

Local Time: 2019-2-14 13:14:52 Monday

Join Status: Activate

RSSI/SNR: 0/0

Channel: 2

Datarate: 2-SF10

Rx2DR: 0-SF12

Analog1: 20°C(20mA)

Analog2: 30mA(30mA)

Input: Low

Output: High

Uplink Frame-counter: 0

Downlink Frame-counter: 0

Firmware Version: 01.08 Hardware Version: V1.01

Status	
Item	Description
Local Time	Show the time of the device.
Join Status	Show if the device joined the network successfully. The "Activate" means the device has joined the network.
RSSI/SNR	Show the RSSI/SNR of received packet.
Channel	Show the the channel currently used by the device to send packets.
Rx2DR	Show the RX2 datarate which used for the RX2 receive-window.
Analog1	Show the value of the Analog Input1. Format: scaled output value (analog input value)
Analog2	Show the value of the Analog Input2. Format: scaled output value (analog input value)
Input	Show the status of Digital Input.
Output	Show the status of Digital Output.
Uplink Frame-counter	The number of data frames sent uplink from UC1122 to the network server.
Downlink Frame-counter	The number of data frames sent downlink from the network server to UC1122.

4.3 General

Click "General" to set the general settings of this device:

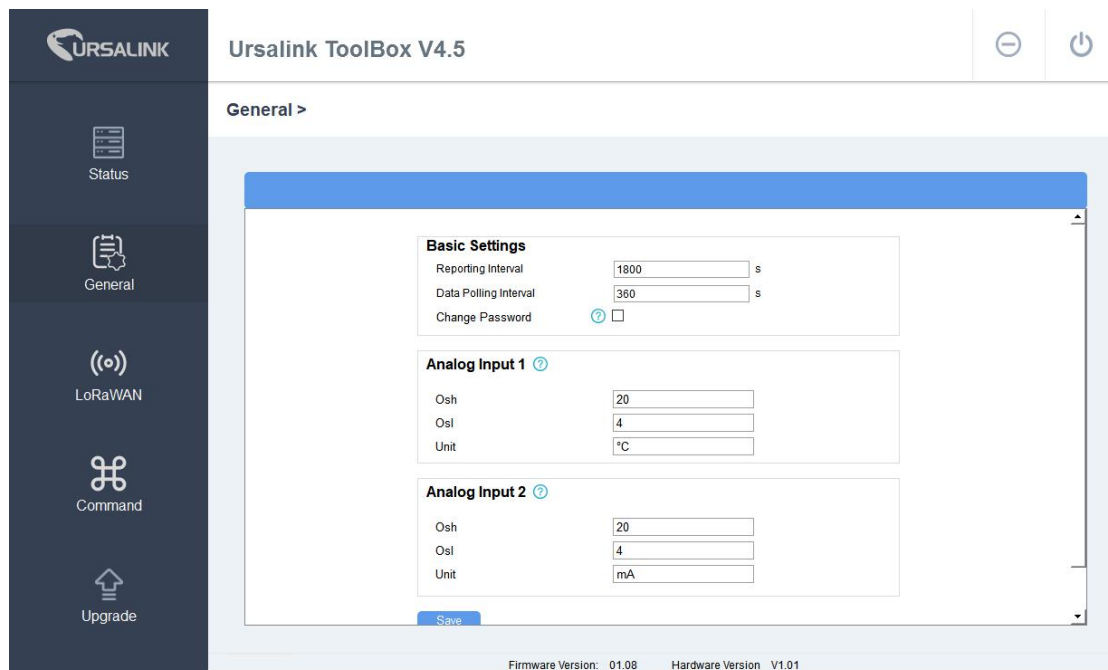

URSALINK
Ursalink ToolBox V4.5

General >

Basic Settings

Reporting Interval s

Data Polling Interval s

Change Password

Analog Input 1

Osh

Osl

Unit

Analog Input 2

Osh

Osl

Unit

Save

Firmware Version: 01.08 Hardware Version V1.01

Basic Setting		
Item	Description	Default
Reporting Interval	Set the regular report interval. The device will send the I/O status/value and signal strength to the user-built server regularly. The interval range is 1-3600 seconds.	1800
Data Polling Interval	The interval of reading data from analog input.	360
Change Password	Click to change password.	Null
Old Password	Enter the old password.	Null
New Password	Enter the new password.	Null
Confirm Password	Enter the new password again.	Null

Analog Input 1 ?

Osh

Osl

Unit

Analog Input 2 ?

Osh

Osl

Unit

ADC Settings		
Item	Description	Default
Analog Input	Show the Analog Input which you set.	Null
Osh	High limit of the scale for the scaled output value.	20.00
Osl	low limit of the scale for the scaled output value.	4.00
Unit	Enter the unit for the scaled output value.	mA

The following variables are pertinent to the scaling formula:

Ov = scaled output value

Iv = analog input value

Osh = high limit of the scale for the scaled output value

Osl = low limit of the scale for the scaled output value

Ish = high limit of the scale for the analog input value

Isl = low limit of the scale for the analog input value

The scaling scheme can be diagrammed as follows:

The following formula for calculating the scaled value can be derived from the diagram:

$$O_v = [(O_{sh} - O_{sl}) * (I_v - I_{sl}) / (I_{sh} - I_{sl})] + O_{sl}$$

This can be rewritten as:

$$O_v = [(O_{sh} - O_{sl}) / (I_{sh} - I_{sl})] * (I_v - I_{sl}) + O_{sl}$$

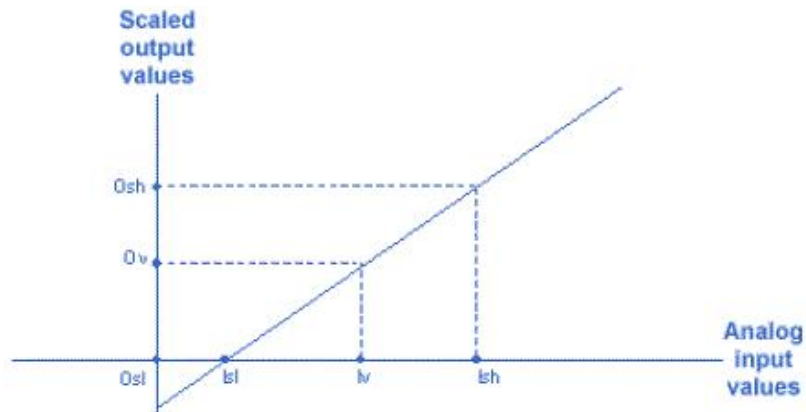

4.4 LoRaWAN

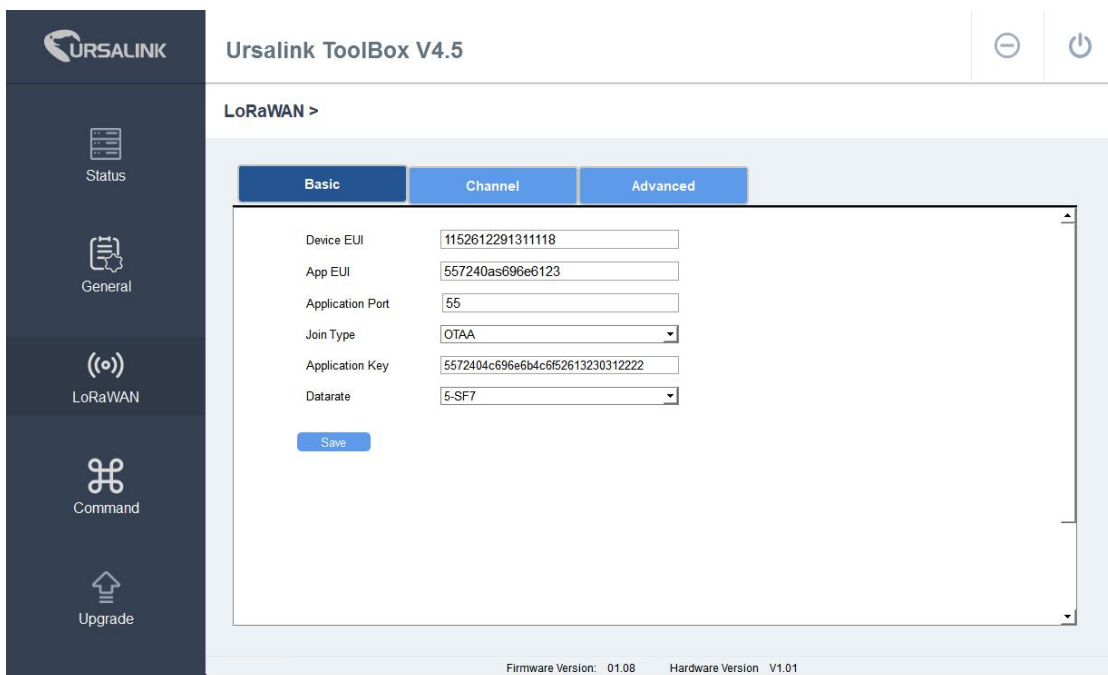

Ursalink ToolBox V4.5

LoRaWAN >

Basic Channel Advanced

Device EUI: 1152612291311118

App EUI: 557240as696e6123

Application Port: 55

Join Type: OTAA

Application Key: 557240c696e6b4c6f52613230312222

Datarate: 5-SF7

Save

Firmware Version: 01.08 Hardware Version: V1.01

Basic Settings

Item	Description	Default
Device EUI	Enter the identifier of the gateway.	Model + SN

App EUI	An AppEUI that will be attached to received packets and a Join EUI.	24e124c0002a0002
Application Port	The port used by the device to send and receive data.	85
Join Type	<p>Select from: "OTAA" and "ABP".</p> <p>OTAA:Over-the-Air Activation.</p> <p>For over-the-air activation, end-devices must follow a join procedure prior to participating in data exchanges with the network server. An end-device has to go through a new join procedure every time it has lost the session context information.</p> <p>ABP: Activation by Personalization.</p> <p>Under certain circumstances, end-devices can be activated by personalization. Activation by personalization directly ties an end-device to a specific network by-passing the join request - join accept procedure.</p>	OTAA
Datarate	The datarate is used to transmit packet.	0-SF12
Regular Report Confirmed	<p>After sending the regular report packet to the network server, if the device does not receive ACK bit from the network server, then the device will resend the packet.</p> <p>Note: If the device doesn't receive ACK for a long time, the device will resend regular report confirmed packets 3 times at most.</p>	Disabled
Alarm Report Confirmed	<p>After sending the attribute package or alarm packet to the network server, if the device does not receive ACK bit from the Network Server, then the device will resend the packet.</p> <p>Note: If the device doesn't receive ACK for a long time, the device will resend regular report confirmed packets 3 times at most. However, the device will resend attribute package all the time.</p>	Disabled

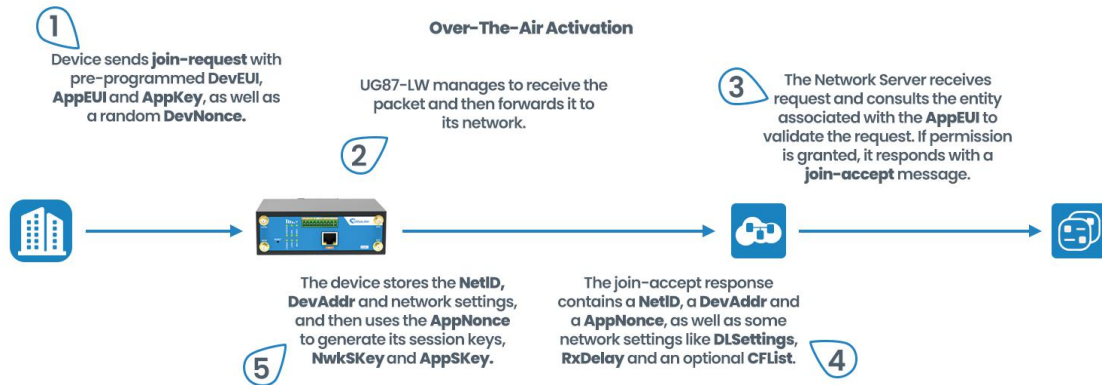

OTAA Settings		
Item	Description	Default
Application Key	Enter the application key. Whenever an end-device joins a network via over-the-air activation, the application key is used for derive the Application Session key.	5572404c696e6b4c6f52613230313823

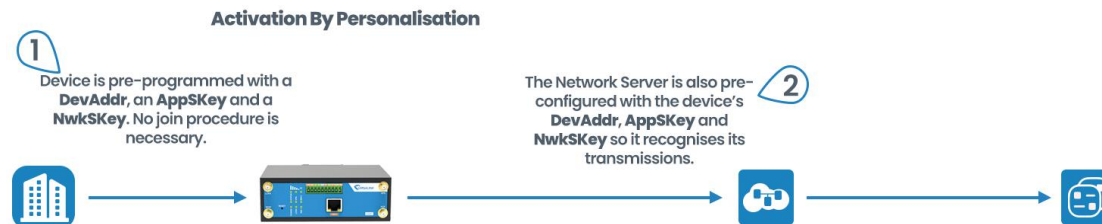

ABP Settings		
Item	Description	Default
Network ID	Network identifier (NwkID) is used to separate addresses of territorially overlapping networks of different network operators and to remedy roaming issues.	010203
Device Address	Enter the device address. The device address identifies the end-device within the current network.	The last 8 digits number of SN
Network Session Key	Enter the network session key of the device. The network session key specific for the end-device. It is used by the end-device to calculate the MIC or part of the MIC (message integrity code) of all uplink data messages to ensure data integrity.	5572404c696e6b4c6f52613230313823
Application Session Key	Enter the application session key of the	5572404c696e

	<p>device. The AppSKey is an application session key specific for the end-device. It is used by both the application server and the end-device to encrypt and decrypt the payload field of application-specific data messages.</p>	<p>6b4c6f5261323 0313823</p>
--	--	----------------------------------

4.4.2 Channel

On this page, you can view all the supported LoRa frequencies and setup the channel frequency used for receiving and sending data.

LoRaWAN >

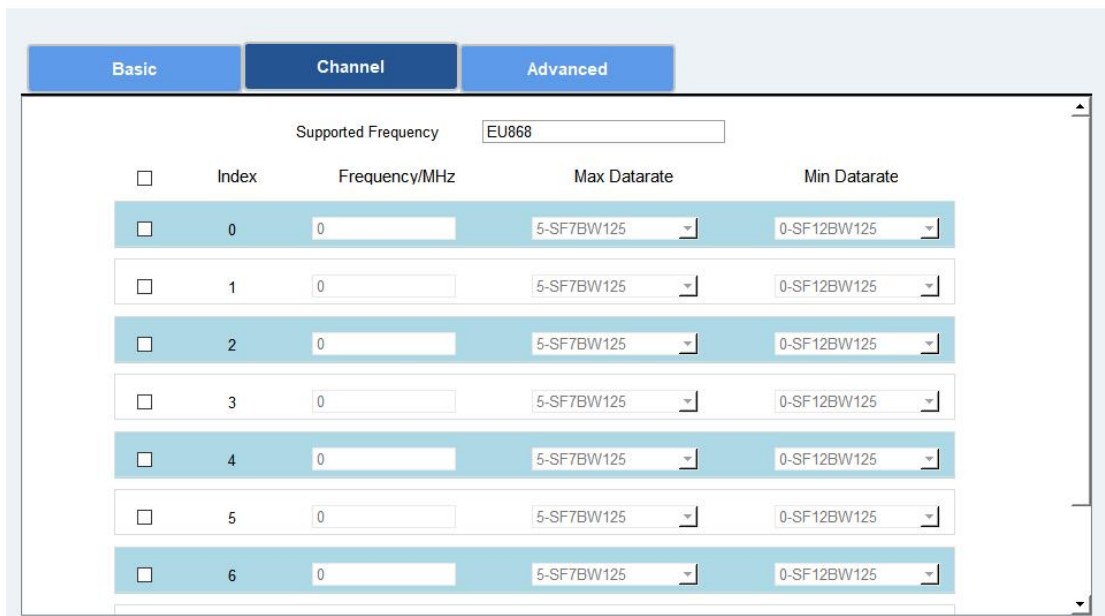

Supported Frequency: EU868				
<input type="checkbox"/>	Index	Frequency/MHz	Max Datarate	Min Datarate
<input type="checkbox"/>	0	0	5-SF7BW125	0-SF12BW125
<input type="checkbox"/>	1	0	5-SF7BW125	0-SF12BW125
<input type="checkbox"/>	2	0	5-SF7BW125	0-SF12BW125
<input type="checkbox"/>	3	0	5-SF7BW125	0-SF12BW125
<input type="checkbox"/>	4	0	5-SF7BW125	0-SF12BW125
<input type="checkbox"/>	5	0	5-SF7BW125	0-SF12BW125
<input type="checkbox"/>	6	0	5-SF7BW125	0-SF12BW125

Note: Make sure that you have configured the corresponding channel on the gateway.
E.g. If you have configured a 923.2 MHz channel on UC1122, then you have to configure a 923.2 MHz channel on gateway as well.



Enable	Index	Radio	Frequency/MHz
<input checked="" type="checkbox"/>	0	Radio 0	923.2
<input checked="" type="checkbox"/>	1	Radio 0	923.4
<input checked="" type="checkbox"/>	2	Radio 0	923.6
<input checked="" type="checkbox"/>	3	Radio 1	922.2
<input checked="" type="checkbox"/>	4	Radio 1	922.4
<input checked="" type="checkbox"/>	5	Radio 1	922.6
<input checked="" type="checkbox"/>	6	Radio 1	922.8
<input checked="" type="checkbox"/>	7	Radio 1	923.0

4.4.3 Advanced

LoRaWAN >

Basic	Channel	Advanced
ADR Mode	<input checked="" type="checkbox"/>	
TXPower	<input type="text" value="16"/>	db
Join Delay1	<input type="text" value="5000"/>	ms
Receive Delay1	<input type="text" value="1000"/>	ms
Receive Delay2	<input type="text" value="2000"/>	ms
Join Trials	<input type="text" value="0"/>	
ReTx	<input type="text" value="3"/>	
RX2 Datarate	<input type="text" value="0-SF12"/>	
RX2 Channel Frequency	<input type="text" value="869.525"/>	MHz
ACK Timeout	<input type="text" value="2000"/>	ms
Duty Cycle Switch	<input type="checkbox"/>	
Duty Cycle	<input type="text" value="0"/>	%
Uplink Frame Counter	<input type="text" value="0"/>	

Advanced Settings		
Item	Description	Default
ADR Mode	<p>ADR Mode: Adaptive Data Rate.</p> <p>Enabled: The Network Server will adjust the datarate by MAC command.</p> <p>Disabled: Whatever how the signal quality is, the Network Server will not adjust the datarate of UC1122.</p>	Enabled
TXPower	The TX (transmit power) setting is used to control the transmission power of the device.	16
Join Delay1	Number of seconds before receive windows are opened for join.	Specified in the LoRaWAN™ Regional Parameters
Receive Delay1	The Join Accept Delay between the end of the Tx and the Join Rx Window 1.	Specified in the LoRaWAN™ Regional

		Parameters
Receive Delay2	The Join Accept Delay between the end of the Tx and the Join Rx Window 2.	Specified in the LoRaWAN™ Regional Parameters
Join Trials	The maximum number of the device to resend the join request when the device failed to join the network.	0
ReTx	The maximum number of the device to resend the data packet if no ACK is received after the specified time. (Must check Confirmed Mode)	3
RX2 Datarate	Datarate for second receive window, which must be the same with Tx Datarate of gateway.	0-SF12
RX2 Channel Frequency	The frequency for second receive window.	Specified in the LoRaWAN™ Regional Parameters
ACK Timeout	Time in milliseconds to wait for ACK before retry of confirmed downlink.	2000
Duty Cycle Switch	Check to enable Duty Cycle.	Disabled
Duty Cycle	Number of minutes in sliding windows for duty cycle restrictions.	0. The 0 means using the standard Duty Cycle which is specified in the LoRaWAN™ Regional Parameters
Uplink Frame Counter	The number of data frames which sent uplink to the network server .It will be incremented by the end-d evice and received by the end-device. Users can reset the a personalized end-device manu ally, then the frame counters on the end-device and the frame counters on the network server for that end-device will be reset to 0.	0
Downlink Frame Counter	The number of data frames which received by the e nd-device downlink from the network server. It will be incremented by the network server.	0

	Users cloud reset the a personalized end-device manually, then the frame counters on the end-device and the frame counters on the network server for that end-device will be reset to 0.	
--	--	--



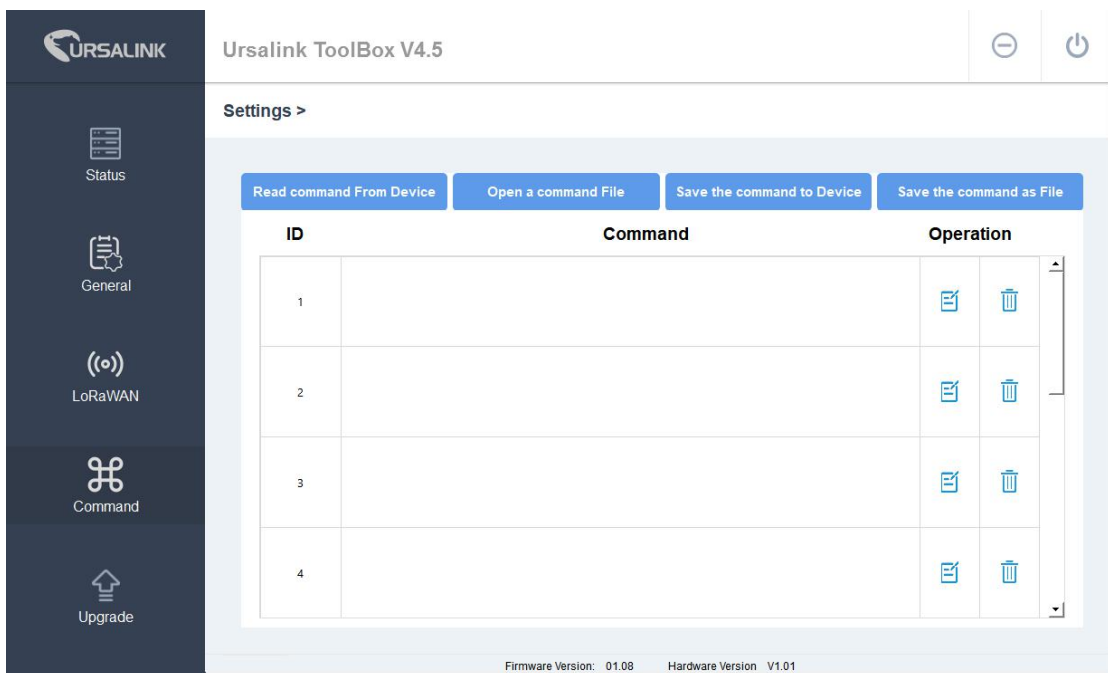





4.5 Command



URSALINK URSALINK
Ursalink ToolBox V4.5

Settings >

Read command From Device Open a command File Save the command to Device Save the command as File

ID	Command	Operation
1		 
2		 
3		 
4		 

Firmware Version: 01.08 Hardware Version V1.01

4.5.1 Read Command from Device

Click "Command" to go to the configuration page. URSALINK Toolbox will read command from the connected device automatically. The whole process takes about 5 seconds.

4.5.2 Open a Command File

You can import the existing command file from your PC with following steps.

1. Click "Open a Command File".
2. Select the command file.

4.5.3 Save the Command to Device

You can click "Save the Command to Device" to save the command having been configured on the Ursalink ToolBox.

4.5.4 Save the Command as File

You can click "Save the Command as File" to save the command having been configured on the Ursalink ToolBox as a file and save it on your computer.

4.6 IF-THEN Behaviour Command

The Ursalink UC1122 is running with a number of defined behaviour commands. Each command takes the form of an IF-THEN statement pair. You are thus able to select certain trigger conditions to cause desired actions. The Ursalink UC1122 allows up to 8 separate behaviour commands with some models.

Users can select time or input constraints for any IF-THEN statement pairs, so that an action will only be triggered during certain period within a day, or only if certain input/output conditions are met.

The user can enter the edit page by clicking  , or delete the command by clicking .

4.6.1 Supported IF Condition

4.6.1.1 IF the Time Is ...

A command containing this IF condition will be triggered at a specific time every day within a specified range of dates, or on every selected day of the week.

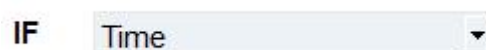

The user can choose the day of the week from:

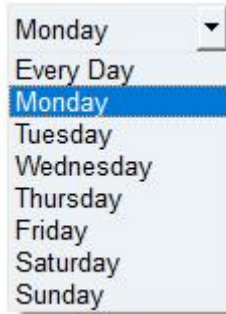

The user can also set the time from 00:00 to 23:59 on a certain day.

4.6.1.2 IF Received a Specific Message

A command containing this IF condition will be triggered by certain message defined by users.



4.6.1.3 IF Digital Input

A command containing this IF condition will be triggered if the selected digital input changed according to the specified option.

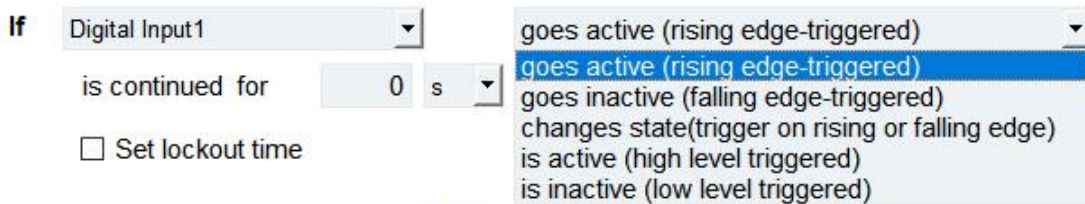

The user can setup multiple combinations; however, digital input 1 be activated before action is taken.

Then the user can choose from the following options.

- Goes active (rising edge-triggered)
- Goes inactive (falling edge-triggered)
- Changes state (triggered on rising or falling edge)
- Is active (high level triggered)
- Is inactive (low level triggered)

Thus, if the user chooses "Goes Active", then as soon as the specified input changes from inactive

to active, the command will be triggered. Also, it applies to the remaining options when the preset conditions are met.

The user is also able to specify a "Continued time" for this command, which will not be triggered until it remains Active or Inactive longer than the time specified. Moreover, the user can specify a "Lockout time" for this command. After the command has been triggered, it will not be allowed to be triggered again until the time specified has elapsed.

When you set the time, you can choose the time unit:

Msec: 0-86400000

sec: 0-86400

min: 0-1440

Only integers are allowed. You can't use the decimal point.

Note: There are 3 single actions at most to be executed for a single trigger condition.

4.6.1.4 IF Analog Input

A statement containing this IF condition will be triggered if the analog voltage measured at the terminals meets the specified requirements.

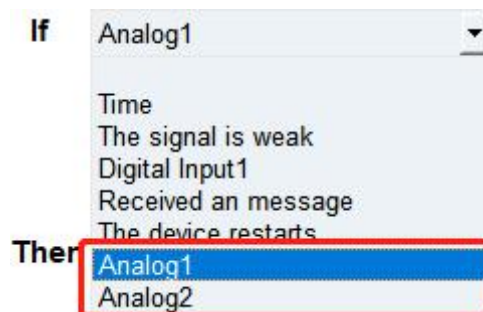

Then the user can choose from the following options:

- above
- below
- within

Thus, if the user chooses , then as soon as the value of this analog input goes above the specified threshold, the statement will be triggered.

Thus, if the user chooses , then as soon as the value of this analog input goes below the specified threshold, the statement will be triggered.

Thus, if the user chooses , to , then as soon as the value of this analog input goes within the specified threshold, the statement will be triggered.

If you select a "Lockout Time" of 10s, a "Continue Time" of 5s, and choose , the statement will be triggered as soon as the value of the selected analog input goes above 10, and remains above 10 for 5s. It will then start checking the value of the selected analog input again after 10s and be triggered once more if the value of the selected analog input is above 10 for 5s.

If the "Lockout Time" is 0, the statement will only be triggered once (will be triggered again when the trigger condition has changed and becomes true again).

Note: The threshold setting range is associated with ADC settings. If you have set up ADC settings, then threshold setting range would be Osh to Osl. If you haven't setup ADC settings, the threshold setting range would be 4 to 20.

4.6.1.5 IF the Device Restarts

A command containing this IF condition will be triggered once the device has finished restarting.

IF

4.6.2 Supported THEN Actions

4.6.2.1 THEN Change Output

A command containing this action will change the selected output according to specified actions.

Then
Delay Time s

The user can choose from the following actions:

- Will be activated
- Will be deactivated
- Will follow the input: When the triggering condition is the input changes state, you can then select change state as the action.

If
 is continued for s
 Set lockout time

Then

If the user has configured:

- "Delay Time", the selected output will be activated after the specified time.
- "Duration", the output will remain current status for a certain period of time.

4.6.2.2 THEN Send A Custom Message

A command containing this Action will send a custom text message via LoRaWAN if the condition is met. Only letter, number, comma, period, separator, space and exclamation mark are allowed in the message, and the maximum character length is 60.

Then **content is**

4.6.2.3 THEN Restart the Device

A command containing this Action will restart the Ursalink UC1122 if the condition is met.

Then

4.7 Upgrade

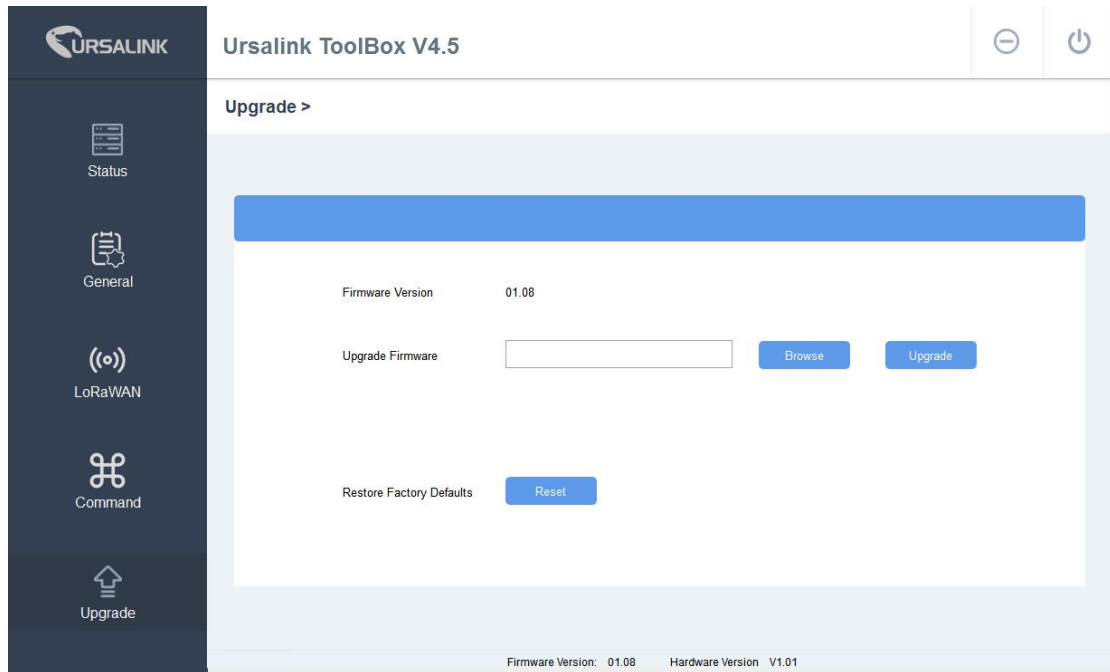

Step 1: Connect UC1122 to PC via USB port.

Step 2: Power on UC1122.

Step 3: Run the URSALINK Toolbox and go to "Upgrade".

Step 4: Click "Browse" and select the correct firmware file from the PC.

Step 5: Click "Upgrade" and the device will check if the firmware file is correct. If it's correct, the firmware will be imported to the device, and the device will restart after upgrading is completed.

Note: Any operation on URSALINK Toolbox is not allowed during upgrading, otherwise the upgrading will be interrupted, or even the device will break down.

Click "Reset", and the device will restore to the factory default settings.

5. Application Examples

5.1 Periodic Status Report

Configuration:

Software:

If

Then content is

UC1122 will send a custom message at 8 a.m. every Monday.

5.2 Control Appliances

5.2.1 Control a Bulb by Sending a Message

In this case we need to turn on or off a 220 V light bulb via a suitable LoRa message.

Hardware:

We connect light bulb to a 220V power source via the output 1 contact on UC1122.

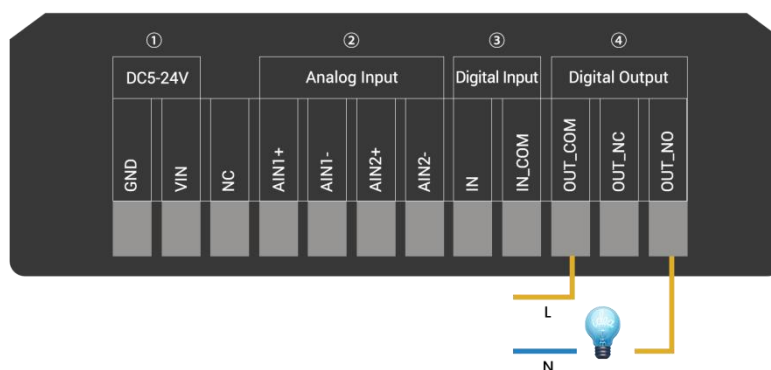

Configuration:

IF containing

Then will be activate

Delay Time s Duration s

5.2.2 Turn on the Heater Regularly

Configuration:

Hardware:

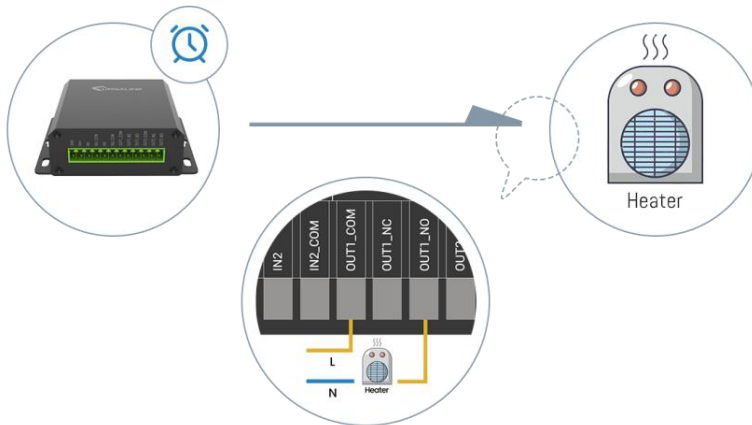

Software:

IF

Then will be activate

Delay Time s Duration min

5.2.3 Send an Alert When Over-temperature Occurs

Configuration:

Hardware:

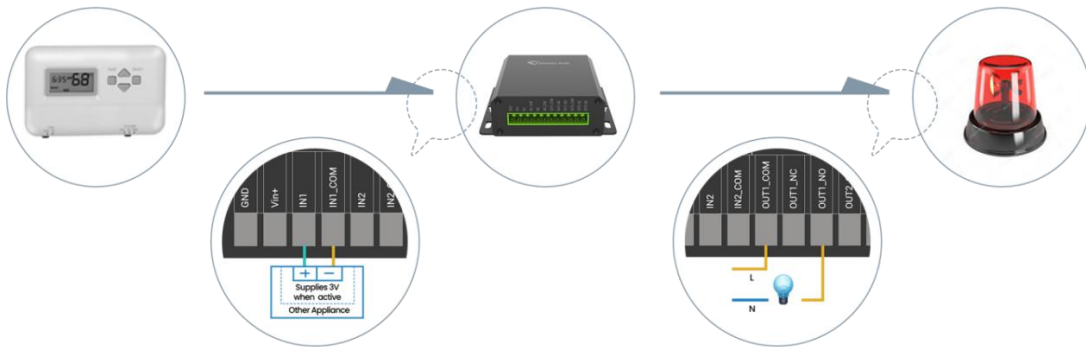

Software:

If Analog1 35 °F
 is continued for 0 s

Set lockout time

Then Output1

Delay Time 0 s Duration 0 s

-END-